

P4R Core

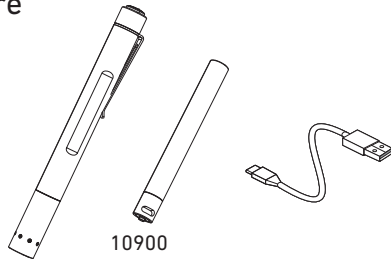

P4R Work

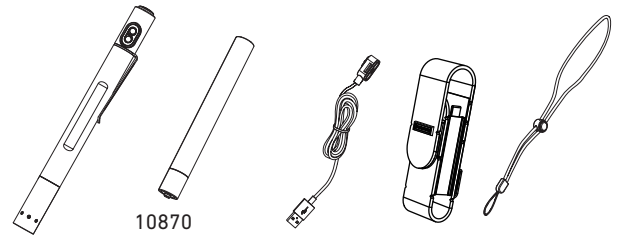

Battery Replacement

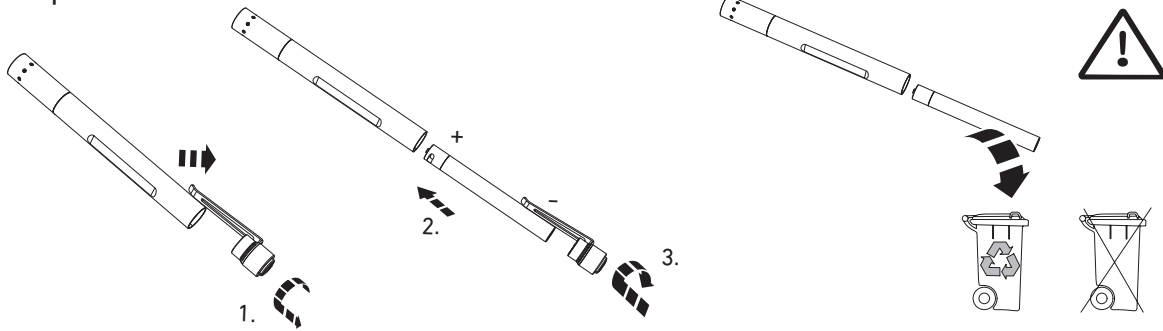

Operation

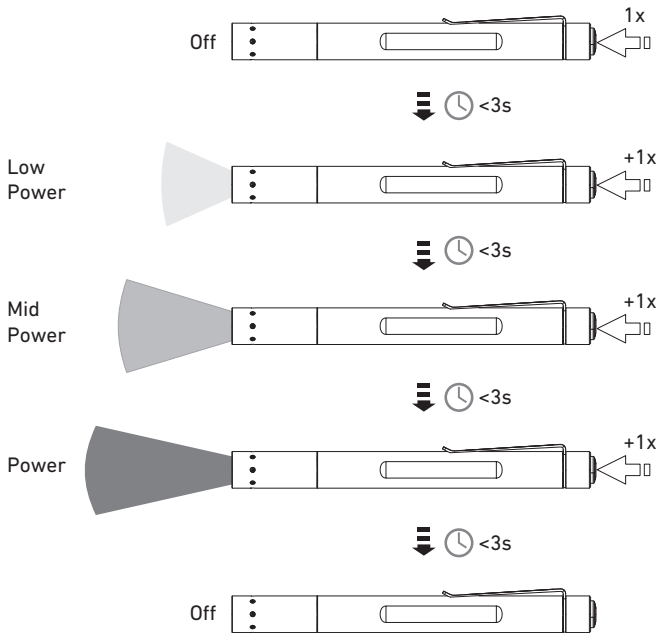

Advanced Focus System

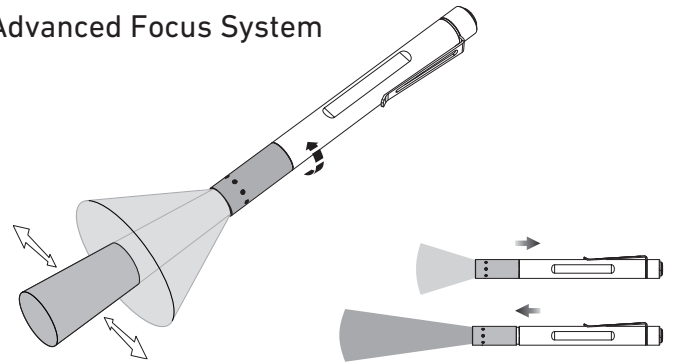

Pouch (P4R Work)

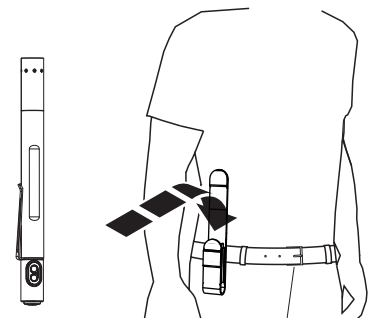

Battery Charging System (P4R Core)

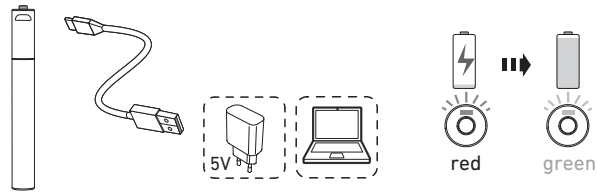

Further Information

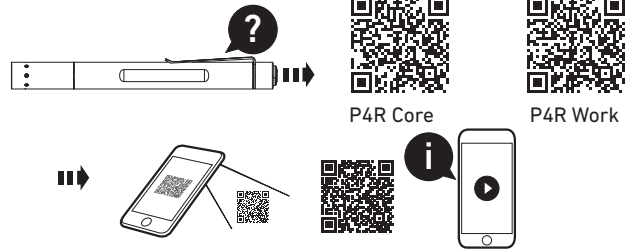

Magnetic Charging System (P4R Work)

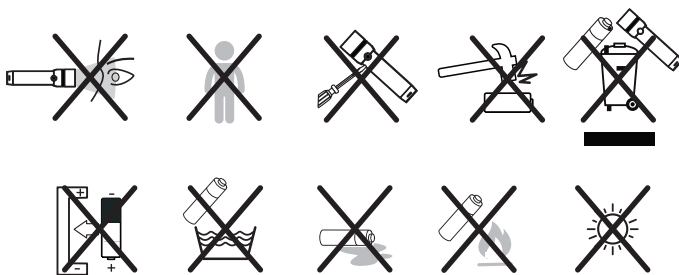
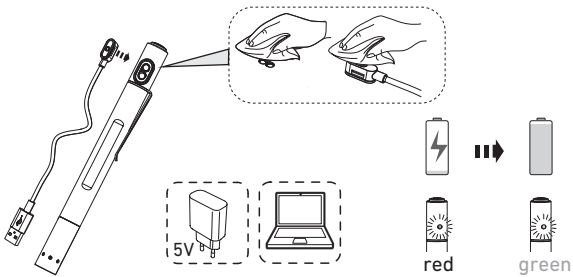

Ledlenser GmbH & Co. KG
 Kronenstr. 5-7 • 42699 Solingen • Germany
 Phone +49 212/5948-0 Fax +49 212/5948-200
 info@ledlenser.com



ledlenser.com



P4R_V01
 29.06.2020
 1J12A0381